

## MOTOR SPECIFICATIONS

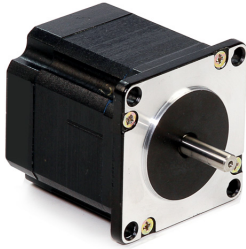

<b>Part Number</b>	<b>5709L-04S</b>
<b>NEMA Size</b>	NEMA 23
<b>Frame Size</b>	57.2mm (2.3 in)
<b>Step Angle</b>	0.9 deg/step
<b>Body Length (Dim. A)</b>	78.2mm (3.1 in)
<b>Current</b>	3.3 Amps/Phase
<b>Holding Torque</b>	1.86 Nm (263 oz-in)
<b>Resistance</b>	0.8 Ohm/Phase
<b>Rotor Inertia</b>	475.55 g-cm <sup>2</sup> (2.6 oz-in)
<b>Number of Leads</b>	4
<b>Connection</b>	Serial
<b>Weight</b>	1 kg (2.2 lb)

## DIMENSIONS

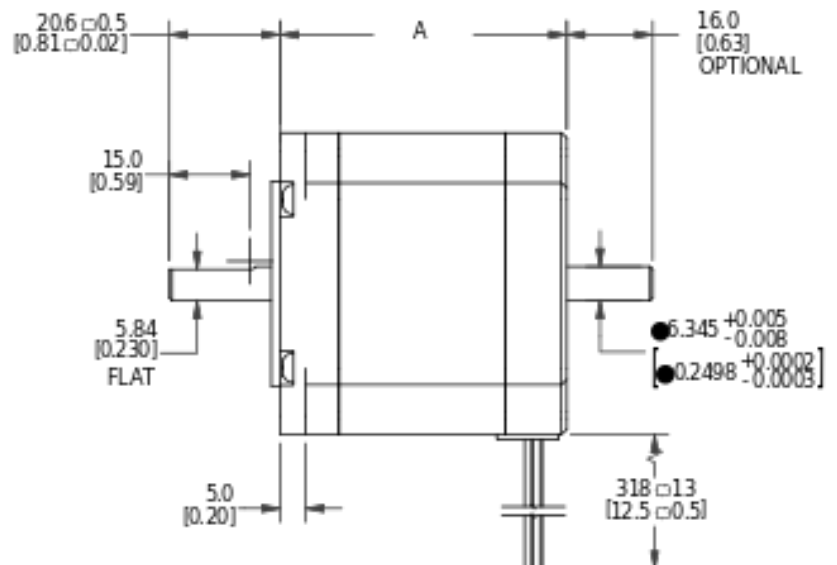
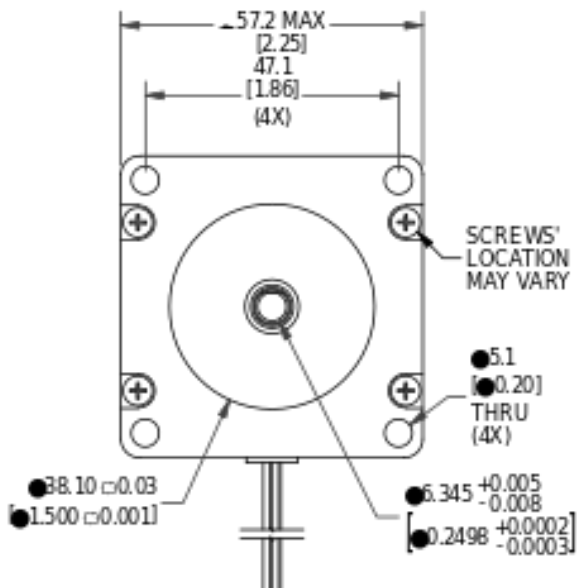

# PERFORMANCE CURVE

## OPERATING CONDITIONS

<b>Radial Play</b>	0.03 mm max @ 0.45 kg load (0.001 in max @ 1 lb load)
<b>End Play</b>	0.08 mm max @ 1.36 kg load (0.003 in max @ 3 lb load)
<b>Shaft Run Out</b>	0.05 mm TIR (0.002 in TIR)
<b>Concentricity of Mounting Pilot to Shaft</b>	0.08 mm TIR (0.003 in TIR)
<b>Perpendicularity of Shaft to Mounting Face</b>	0.08 mm TIR (0.003 in TIR)
<b>Max Axial Load</b>	2.72 kg (6 lb)
<b>Maximum Case Temperature</b>	80 deg C
<b>Ambient Temperature</b>	-20 to 50 deg C
<b>Storage Temperature</b>	-20 to 100 deg C
<b>Humidity Range</b>	85% or less, non-condensing
<b>Magnet Wire Insulation</b>	Class B 180° C*
<b>Insulation Resistance</b>	100 Ohm at 500 VCD
<b>Dielectric Strength</b>	500 VCD for 1 min

## OPERATION & USAGE TIPS

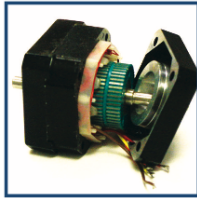

**Do not** disassemble motors; a significant reduction in motor performance will occur.

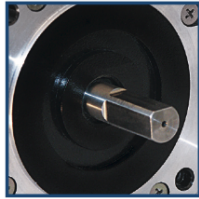

**Do not** machine shafts; this will have a negative effect on shaft run out and perpendicularity.

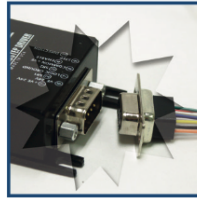

**Do not** disconnect motor from drive while in operation.

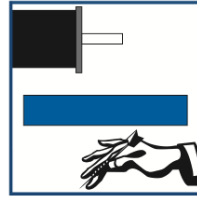

**Do not** use holding torque/detent torque of motor as a fail safe brake.

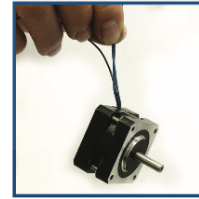

**Do not** hold motor by lead wires.



**Do not** exceed the rated current; this will burn the motor.

FAILURE TO COMPLY WITH THESE RECOMMENDATIONS WILL VOID ALL WARRANTY TERMS

## WIRING TABLE

COLOR	FUNCTION
Red	A+ Phase
Blue	A- Phase
Green	B + Phase
Black	B- Phase

## RECOMMENDED DRIVERS/CONTROLLERS



Single Axis Controller+Driver  
**R356**



Microstepping Driver  
**R701P-RO**

# Motion Control, **Solved.**

## MOTOR ENGINEERING & MANUFACTURING



Optimized  
For Your  
Application



Quick  
Prototype  
Turnaround



Small Batch  
to OEM Volume  
Production



US Based  
Support &  
Manufacturing